



AUTOMATIC WASHER
USE & CARE GUIDE

FOR QUESTIONS ABOUT FEATURES, OPERATION/PERFORMANCE,
PARTS, ACCESSORIES OR SERVICE CALL: 1.800.688.9900

VISIT OUR WEBSITE AT WWW.MAYTAG.COM

TABLE OF CONTENTS

WASHER SAFETY	2	WASHER USE	13
INSTALLATION REQUIREMENTS	4	Starting Your Washer	13
Tools and Parts	4	WASHER CARE	15
Location Requirements	4	Cleaning Your Washer	15
Drain System	5	Water Inlet Hoses.....	15
Electrical Requirements	6	Moving and Storage	15
INSTALLATION INSTRUCTIONS	7	TROUBLESHOOTING	16
Before You Start.....	7	Washer and Components.....	16
Remove Shipping Materials	7	Washer Operation	16
Connect Drain Hose.....	8	Washer Results.....	17
Connect the Inlet Hoses.....	9	ASSISTANCE OR SERVICE	18
Secure the Drain Hose.....	10	NOTES	19
Level the Washer.....	11		
Complete Installation.....	12		

WASHER SAFETY

Your safety and the safety of others are very important.

We have provided many important safety messages in this manual and on your appliance. Always read and obey all safety messages.



This is the safety alert symbol.

This symbol alerts you to potential hazards that can kill or hurt you and others.

All safety messages will follow the safety alert symbol and either the word “DANGER” or “WARNING.”

These words mean:

⚠ DANGER

You can be killed or seriously injured if you don't immediately follow instructions.

⚠ WARNING

You can be killed or seriously injured if you don't follow instructions.

All safety messages will tell you what the potential hazard is, tell you how to reduce the chance of injury, and tell you what can happen if the instructions are not followed.

IMPORTANT SAFETY INSTRUCTIONS

WARNING: To reduce the risk of fire, electric shock, or injury to persons when using the washer, follow basic precautions, including the following:

- Read all instructions before using the washer.
- Do not wash articles that have been previously cleaned in, washed in, soaked in, or spotted with petrol, dry-cleaning solvents, other flammable or explosive substances as they give off vapours that could ignite or explode.
- Do not add gasoline, dry-cleaning solvents, or other flammable, or explosive substances to the wash water. These substances give off vapours that could ignite or explode.
- Under certain conditions, hydrogen gas may be produced in a hot water system that has not been used for 2 weeks or more. **HYDROGEN GAS IS EXPLOSIVE.** If the hot water system has not been used for such a period, before using the washing machine, turn on all hot water taps and let the water flow from each for several minutes. This will release any accumulated hydrogen gas. As the gas is flammable, do not smoke or use an open flame during this time.
- Do not allow children to play on or in the washer. Close supervision of children is necessary when the washer is used near children.
- The appliance is not intended for use by young children or infirm persons without supervision.
- Before the washer is removed from service or discarded, remove the door or lid.
- Do not reach into the washer if the drum, tub or agitator is moving.
- Do not install or store the washer where it will be exposed to the weather.
- Do not tamper with controls.
- Do not repair or replace any part of the washer or attempt any servicing unless specifically recommended in this Use and Care Guide or in published user-repair instructions that you understand and have the skills to carry out.
- See installation Instructions for grounding requirements.
- If the supply cord is damaged, it must be replaced by the manufacturer or its service agent or a similarly qualified person in order to avoid a hazard.

SAVE THESE INSTRUCTIONS

INSTALLATION REQUIREMENTS

Tools and Parts

Gather the required tools and parts before starting installation. The parts supplied are in the washer basket.

Tools needed for connecting the drain hose and water inlet hoses:

- Pliers that open to 1 $\frac{1}{16}$ " (3.95 cm)
- Flashlight (optional)
- Flat-blade screwdriver

Parts supplied:

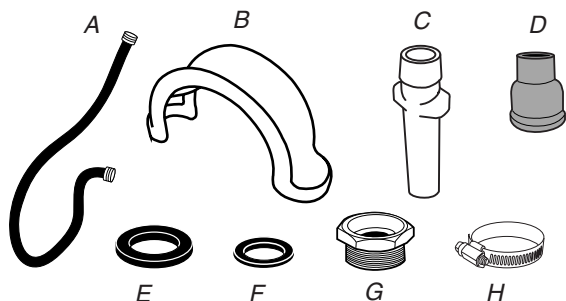

- A. Water inlet hose (2)
- B. Drain hose form
- C. Drain hose extension
- D. Drain hose coupling
- E. Large flat washer (4)
- F. Small flat washer (2)
- G. Inlet hose adapter
- H. Hose clamp (2)

Tools needed for securing the drain hose and leveling the washer:

- Adjustable or open end wrench $\frac{9}{16}$ " (14 mm)
- Level
- Wood block
- Ruler or measuring tape

Parts supplied:

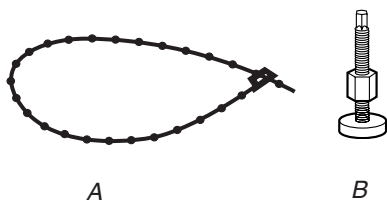

- A. Beaded tie strap
- B. Front leveling feet with nuts (2)

Alternate Parts

Your installation may require additional parts. For information on ordering, please refer to the toll-free phone numbers on the front page of the Use and Care Guide.

If You Have:	You Will Need to Buy:
Laundry tub or standpipe taller than 96"(2.4 m)	Sump pump system (if not already available)
Overhead sewer	Standard 20 gal. (76 L) 39"(99 cm) tall drain tub or utility sink, sump pump and connectors (available from local plumbing suppliers)
Floor drain	Siphon break kit, Part Number 280129; additional drain hose, Part Number 3357090
Water faucets beyond reach of fill hoses	2 longer water fill hoses: 6 ft (1.8 m) Part Number 76314, 10 ft (3.0 m) Part Number 350008
Drain hose too short	Drain hose kit, Part Number 280131
Lint clogged drain	Drain protector, Part Number 367031

Location Requirements

Selecting the proper location for your washer improves performance and minimizes noise and possible washer "walk."

Your washer can be installed in a basement, laundry room, closet, or recessed area. See "Drain System."

IMPORTANT: Do not install or store the washer where it will be exposed to the weather. Proper installation is your responsibility.

You will need:

- A water heater set to deliver 120°F (49°C) water to the washer.
- A grounded electrical outlet located within 4 ft (1.2 m) of where the power cord is attached to the back of the washer. See "Electrical Requirements."
- Hot and cold water faucets located within 3 ft (90 cm) of the hot and cold water fill valves, and water pressure of 5-100 psi (34.5-690 kPa). Washers with triple dispensers require 20-100 psi (138-690 kPa) for best performance.
- A level floor with a maximum slope of 1" (2.5 cm) under entire washer. Installing the washer on carpeting is not recommended.
- A sturdy floor to support the washer weight (washer, water and load) of 315 lbs (143 kgs).

Do not store or operate your washer in temperatures at or below 32°F (0°C). Some water can remain in the washer and can cause damage in low temperatures. See "Washer Care."

Recessed area or closet installation

The dimensions shown are for the recommended spacing allowed (A and B), except the closet door ventilation openings. The dimensions shown for the closet door ventilation openings (C) are the minimum required.

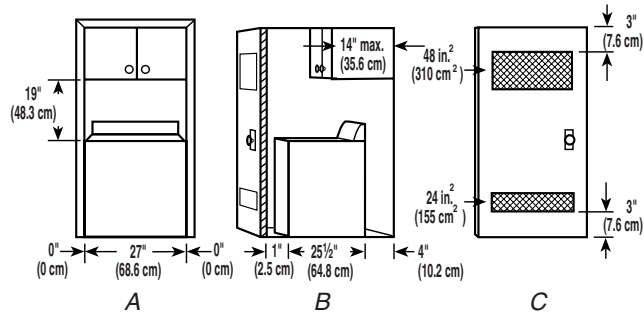

A. Front view
B. Side view
C. Closet door with vents

- Additional spacing should be considered for ease of installation and servicing.
- Additional clearances may be required for wall, door and floor moldings.
- Additional spacing of 1" (2.5 cm) on all sides of the washer is recommended to reduce noise transfer.
- If a closet door is installed, the minimum air openings in the top and bottom of the door are required (C). Louvered doors with air openings in the top and bottom are acceptable.
- Companion appliance spacing should also be considered.

Drain System

The washer can be installed using the standpipe drain system (floor or wall), the laundry tub drain system, or the floor drain system. Select the drain hose installation method you need. See "Tools and Parts."

Standpipe drain system—wall or floor (views A & B)

The standpipe drain requires a minimum diameter standpipe of 2" (5 cm). The minimum carry-away capacity can be no less than 17 gal. (64 L) per minute. A 1¼" (3.2 cm) diameter to 1" (2.5 cm) diameter standpipe adapter kit is available. See "Tools and Parts."

The top of the standpipe must be at least 39" (99 cm) high and no higher than 96" (244 cm) from the bottom of the washer.

To avoid siphoning, no more than 8" (20.3 cm) of drain hose should be inside the standpipe. Secure drain hose with beaded tie strap.

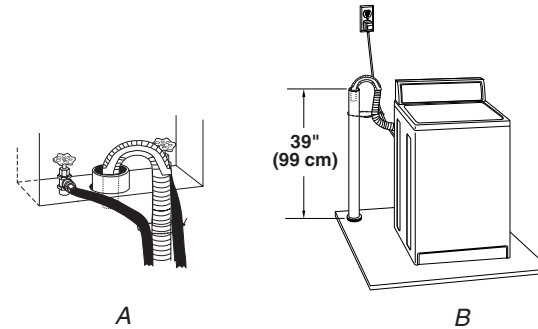

Laundry tub drain system (view C)

The laundry tub needs a minimum 20 gal. (76 L) capacity. The top of the laundry tub must be at least 39" (99 cm) above the floor and no higher than 96" (244 cm) from the bottom of the washer.

Floor drain system (view D)

The floor drain system requires a siphon break that may be purchased separately. See "Tools and Parts."

The siphon break must be a minimum of 28" (71 cm) from the bottom of the washer. Additional hoses might be needed.

To avoid siphoning, no more than 8" (20.3 cm) of drain hose should be below the top of the wash tub. Secure drain hose with beaded tie strap.

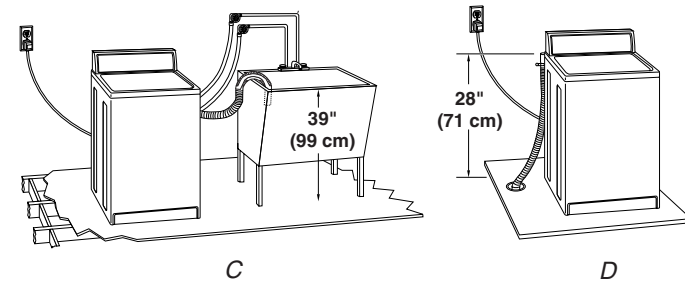

Electrical Requirements

⚠ WARNING



Electrical Shock Hazard

Plug into a grounded 3 prong outlet.

Do not remove ground prong.

Do not use an adapter.

Do not use an extension cord.

Failure to follow these instructions can result in death, fire, or electrical shock.

- A 120 volt, 50 Hz., AC only, 15- or 20-amp, fused electrical supply is required. A time-delay fuse or circuit breaker is recommended. It is recommended that a separate circuit serving only this appliance be provided.
- This washer is equipped with a power supply cord having a grounding plug.
- To minimize possible shock hazard, the cord must be plugged into a mating, grounding-type outlet, grounded in accordance with local codes and ordinances. If a mating outlet is not available, it is the personal responsibility and obligation of the customer to have the properly grounded outlet installed by a qualified electrician.
- If codes permit and a separate ground wire is used, it is recommended that a qualified electrician determine that the ground path is adequate.
- Do not ground to a gas pipe.
- Check with a qualified electrician if you are not sure the washer is properly grounded.
- Do not have a fuse in the neutral or ground circuit.

GROUNDING INSTRUCTIONS

For a grounded, cord-connected washer:

This washer must be grounded. In the event of a malfunction or breakdown, grounding will reduce the risk of electrical shock by providing a path of least resistance for electric current. This washer is equipped with a cord having an equipment-grounding conductor and a grounding plug. The plug must be plugged into an appropriate outlet that is properly installed and grounded in accordance with all local codes and ordinances.

WARNING: Improper connection of the equipment-grounding conductor can result in a risk of electric shock. Check with a qualified electrician or serviceman if you are in doubt as to whether the appliance is properly grounded.

Do not modify the plug provided with the appliance – if it will not fit the outlet, have a proper outlet installed by a qualified electrician.

For a permanently connected washer:

This washer must be connected to a grounded metal, permanent wiring system, or an equipment grounding conductor must be run with the circuit conductors and connected to the equipment-grounding terminal or lead on the appliance.

INSTALLATION INSTRUCTIONS

Before You Start

! WARNING

Excessive Weight Hazard

**Use two or more people to move and install washer.
Failure to do so can result in back or other injury.**

NOTE: To avoid floor damage, set the washer onto cardboard before moving across floor.

Remove Shipping Materials

Removing the shipping material is necessary for proper operation. If the shipping material is not removed, the washer will make excessive noise.

1. Move the washer to within approximately 3 ft (90 cm) of its final location.
2. The washer must be in the upright position and not tilted before removing the shipping material.
3. Locate the yellow shipping materials on the rear of the machine, near the bottom. Follow the steps for your particular model, either the one with the straight power cord and cord restraint or the looped power cord version.

Straight power cord

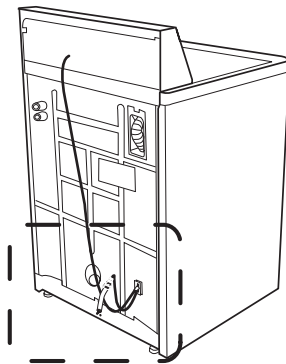

Straight power cord

1. Remove power plug and yellow strap from machine base to release the rear leveling system.

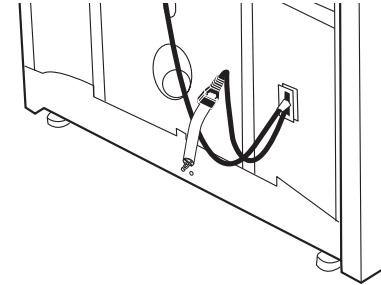

2. Firmly grasp the power cord and pull to completely remove the power cord, cord restraint, and pin from the rear panel.

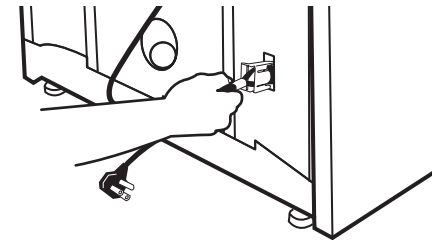

3. Confirm that the power cord restraint (A), and pin (B) are removed.

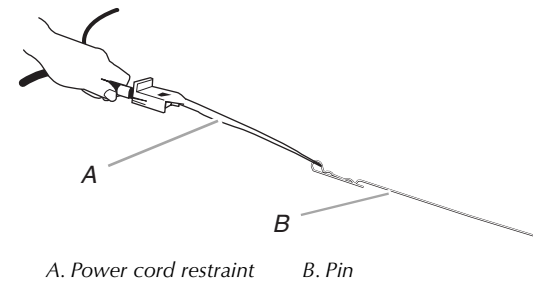

4. To remove the power cord from the cord restraint, push the power cord in, press TAB, and then pull the power cord out.

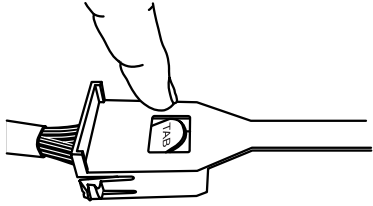

Looped power cord

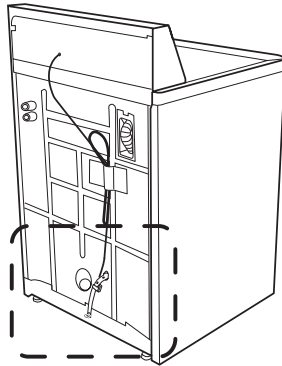

Looped power cord

1. Firmly grasp the yellow shipping strap and pull until both ends are completely removed from washer.

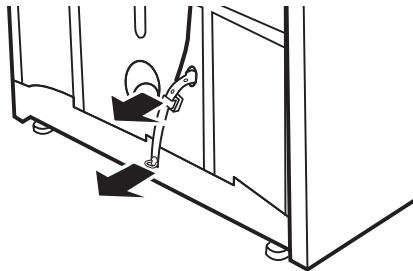

2. Check that two (2) cotter pins were removed with the shipping strap.

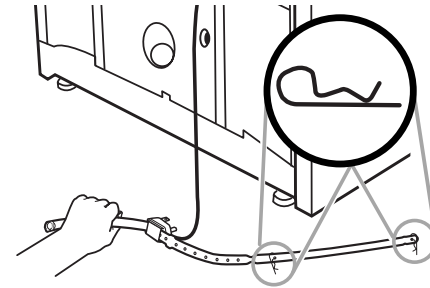

Connect Drain Hose

Proper connection of the drain hose protects your floors from damage due to water leakage. Read and follow these instructions.

The drain hose is connected to your washer and is stored inside the washer cabinet.

Remove drain hose from washer cabinet

Gently pull the corrugated drain hose out of the washer from the top of the hose. Continue to pull the hose until the end emerges. Do not force excess drain hose back into the rear of the washer.

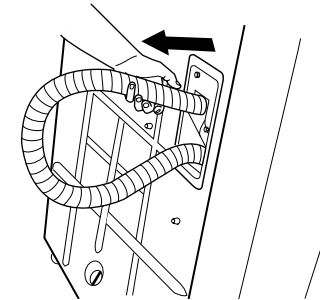

Laundry tub drain or standpipe drain

Connecting the drain hose form to the corrugated drain hose

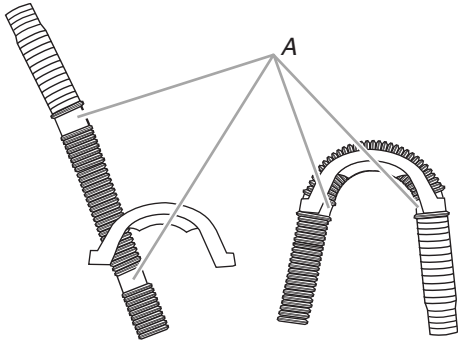

A. Drain hose reliefs

1. Feed end of drain hose into one end of form. Place end of drain hose form into the drain hose relief.
2. Bend the hose over the top of the form and feed into the other end of the form.

To keep drain water from going back into the washer:

- Do not force excess drain hose into standpipe. Hose should be secure but loose enough to provide a gap for air.
- Do not lay excess hose on the bottom of the laundry tub.

Floor drain

Do not install the drain hose form on to the corrugated drain hose. You may need additional parts. See Floor drain under "Tools and Parts."

Connect the Inlet Hoses

The washer must be connected to the water faucets using the new inlet hoses. Do not use old hoses.

Insert new flat washers (supplied) into each end of the inlet hoses. Firmly seat the washers in the couplings.

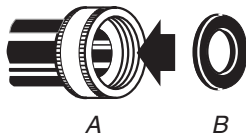

A. Coupling

B. Washer

Connect the inlet hoses to the water faucets

Make sure the washer basket is empty.

1. Attach the hose labeled hot to the hot water faucet. Screw on coupling by hand until it is seated on the washer.
2. Attach the hose labeled cold to the cold water faucet. Screw on coupling by hand until it is seated on the washer.
3. Using pliers, tighten the couplings with an additional two-thirds turn.

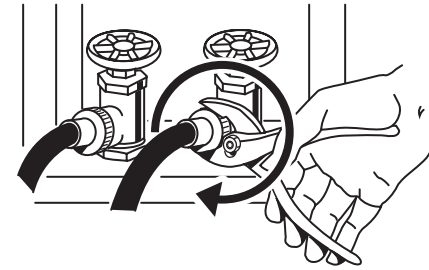

NOTE: Do not overtighten or use tape or sealants on the valve. Damage to the valves can result.

Clear the water lines

- Run water through both faucets and inlet hoses, into a laundry tub, drainpipe or bucket, to get rid of particles in the water lines that might clog the inlet valve screens.
- Check the temperature of the water to make sure that the hot water hose is connected to the hot water faucet and that the cold water hose is connected to the cold water faucet.

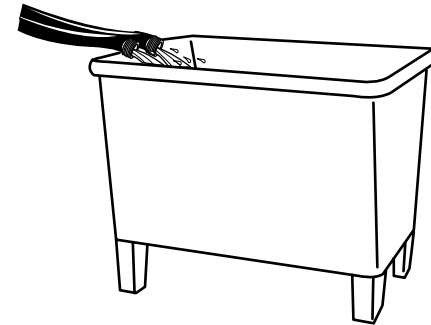

Connect the inlet hoses to the washer

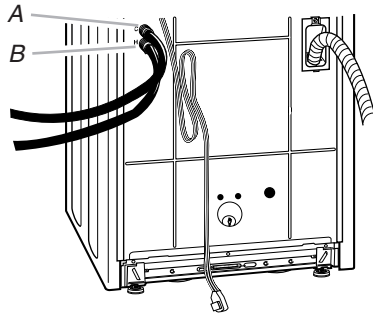

A. Cold water inlet valve
B. Hot water inlet valve

1. Attach the hot water hose to the bottom inlet valve.
2. Attaching the hot water coupling first makes it easier to tighten connection with pliers.
3. Screw on coupling by hand until it is seated on the washer.

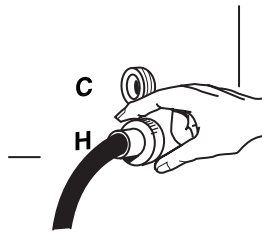

4. Using pliers, tighten the couplings with an additional two-thirds turn.
NOTE: Do not overtighten or use tape or sealants on the valve. Damage to the valves can result.

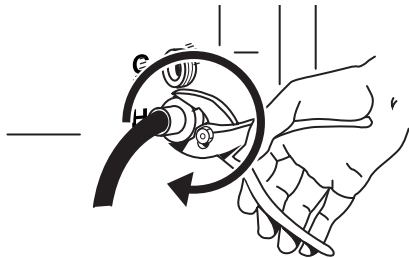

5. Attach the cold water hose to the top inlet valve.
6. Screw on coupling by hand until it is seated on the washer.
7. Using pliers, tighten the couplings with an additional two-thirds turn.
NOTE: Do not overtighten or use tape or sealants on the valve. Damage to the valves can result.

Check for leaks

Turn on the water faucets and check for leaks. A small amount of water might enter the washer. You will drain this later.

NOTE: Replace inlet hoses after 5 years of use to reduce the risk of hose failure. Record hose installation or replacement dates for future reference.

- If you connect only one water hose, you must cap off the remaining water inlet port.
- Periodically inspect and replace hoses if bulges, kinks, cuts, wear, or leaks are found.

Secure the Drain Hose

1. Remove the shipping material from the power cord. Drape the power cord over the console.
2. Remove any cardboard used to move washer.

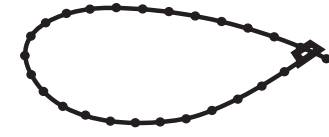

Beaded tie strap

3. Wrap the drain hose to the laundry tub leg, drain standpipe or inlet hoses, with the beaded tie strap. Push fastener into the nearest hole in the beaded tie strap. See view A or B.

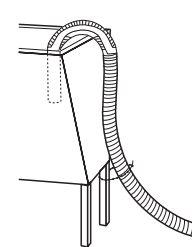

A

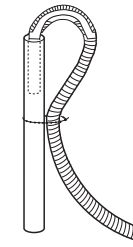

B

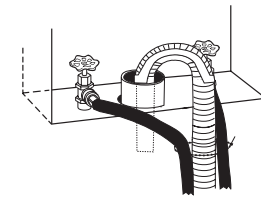

C

If the washer faucets and the drain standpipe are recessed, put the formed end of the drain hose into the standpipe. Tightly wrap the tie strap around the water inlet hoses and the drain hose. See view C.

Level the Washer

Properly leveling your washer avoids excessive noise and vibration.

Install the Front Leveling Feet

1. Prop up the front of the washer about 4" (10.2 cm) with a wood block or similar object. The block needs to support the weight of the washer.

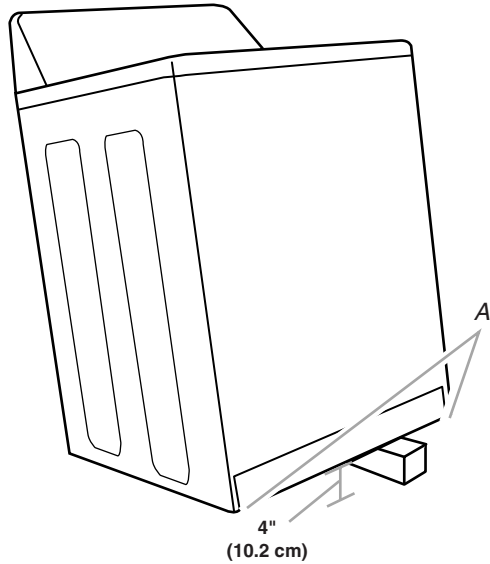

A. Threaded holes for feet

2. Screw the locknut onto each foot to within 1" (2.5 cm) of the foot base.

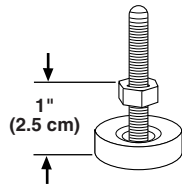

3. Screw the feet into the threaded holes at the front corner of the washer until the nuts touch the washer. Twist the feet to install.

NOTE: Do not tighten the nuts until the washer is level.

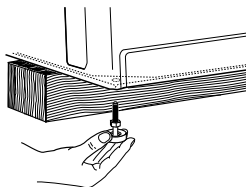

4. Tilt the washer back and remove the wood block. Gently lower the washer to the floor.

Steps in Final Location

1. Slide the washer to its final location.
2. Tilt the washer forward until the rear of the washer is at least 4" (10.2 cm) off the floor. You may hear the self-adjusting rear feet click into place. Lower the washer to the floor.

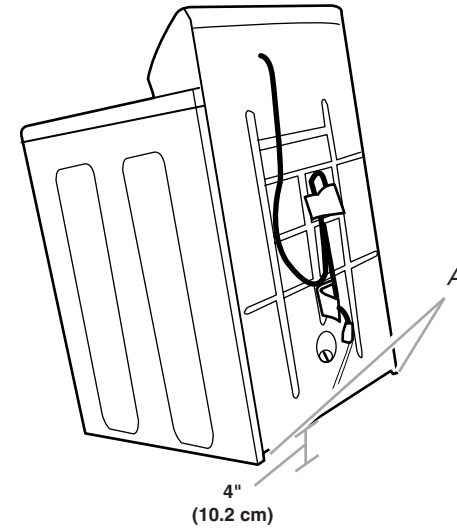

A. Self-adjusting feet

3. Check the levelness of the washer by placing a level on the top edges of the washer, first side to side, then front to back.

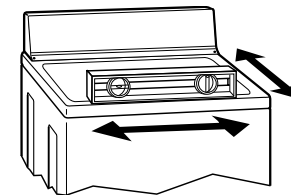

4. If the washer is not level, move the washer out slightly, tip back, prop up the front of the washer with the wood block and adjust the feet up or down as necessary by twisting the feet. Turn the feet clockwise to raise the washer or counterclockwise to lower the washer. Repeat steps 1 through 4 until washer is level.

5. After the washer is in the final location and level, use a $\frac{9}{16}$ " or 14 mm open-end wrench to turn the nuts counterclockwise on the feet tightly against the washer cabinet.

IMPORTANT: If the nuts are not tight against the washer cabinet, the washer may vibrate.

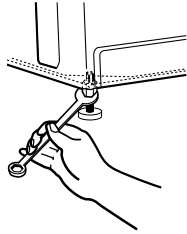

Complete Installation

1. Check the electrical requirements. Be sure that you have the correct electrical supply and the recommended grounding method. See "Electrical Requirements."
2. Check that all parts are now installed. If there is an extra part, go back through the steps to see which step was skipped.
3. Check that you have all of your tools.
4. Check that the yellow shipping strap was removed from the back of the washer and used to secure the drain hose.
5. Dispose of/recycle all packaging materials.

6. Check that the water faucets are on.
7. Check for leaks around faucets and inlet hoses.

⚠ WARNING



Electrical Shock Hazard

Plug into a grounded 3 prong outlet.

Do not remove ground prong.

Do not use an adapter.

Do not use an extension cord.

Failure to follow these instructions can result in death, fire, or electrical shock.

8. Plug into a grounded 3 prong outlet.
9. Remove the protective film on the console and any tape remaining on the washer.
10. Read "Washer Use" in the Washer User Instructions.
11. To test your washer, measure $\frac{1}{2}$ of the normal recommended amount of powdered or liquid detergent and pour it into the washer basket or detergent dispenser (on some models). Close the lid. Select any cycle, and then pull the cycle control knob out to start the washer. Allow it to complete one whole cycle.

WASHER USE

Starting Your Washer

⚠ WARNING



Fire Hazard

Never place items in the washer that are dampened with gasoline or other flammable fluids.

No washer can completely remove oil.

Do not dry anything that has ever had any type of oil on it (including cooking oils).

Doing so can result in death, explosion, or fire.

WARNING: To reduce the risk of fire, electric shock, or injury to persons, read the IMPORTANT SAFETY INSTRUCTIONS before operating this appliance.

⚠ WARNING



Electrical Shock Hazard

Plug into a grounded 3 prong outlet.

Do not remove ground prong.

Do not use an adapter.

Do not use an extension cord.

Failure to follow these instructions can result in death, fire, or electrical shock.

1. Measure detergent and pour it into the washer. If desired, add powdered or liquid color safe bleach.
2. Drop a sorted load of clothes loosely into your washer.
 - Load evenly to maintain washer balance. Mix large and small items. Items should move easily through the wash water.
 - Load only to the top of the basket as shown. Overloading can cause poor cleaning.

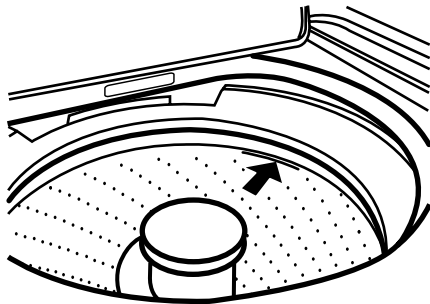

3. (OPTIONAL) Add liquid chlorine bleach.

NOTE: Follow the garment and the chlorine bleach manufacturers' directions for proper use. Undiluted bleach will damage any fabric it touches. The damage appears as rips, holes, tears, or color loss and may not show up until several washings later. To avoid spilling, use a cup with a pouring spout. Do not let bleach splash, drip, or run down into the washer basket. Always measure liquid chlorine bleach. Do not guess. Do not use more than the manufacturer's recommended amount for a full load. Use less with a smaller load size.

Styles 1 and 2: With liquid chlorine bleach dispenser (on some models)

- Use only liquid chlorine bleach in this dispenser. Do not use this dispenser to add powdered chlorine or color-safe bleach to your wash load. Pour measured liquid chlorine bleach into the liquid chlorine bleach dispenser. Bleach is immediately fed into the washer and is diluted automatically during the wash part of the cycle.

- Dispensers on Timed Bleach models automatically dispense bleach at the proper time in the cycle for optimal performance, ensuring the cleanest and brightest loads.

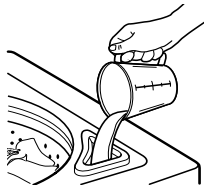

Style 1
Liquid chlorine
bleach dispenser
(on some models)

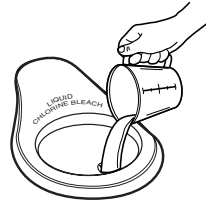

Style 2
Dispenser for
Timed Bleach models

Style 3: Without liquid chlorine bleach dispenser (on some models)

- Let the washer fill and begin agitating the load.
 - Add bleach 5 minutes into the wash cycle for best cleaning and so that bleach can be removed in the rinse cycle. Pour bleach around the agitator, not directly onto the load to avoid damaging clothing or other items in the load.
4. (OPTIONAL) Add liquid fabric softener.

NOTE: Do not spill or drip any fabric softener onto the clothes. Undiluted fabric softener can stain fabrics. Always dilute fabric softener with warm water. Using too much fabric softener can make some items (diapers and towels) nonabsorbent. If this happens, do not use it in every load, or use less of it in each load.

Style 1: With liquid fabric softener dispenser (on some models)

- Use only liquid fabric softener in this dispenser. Pour measured liquid fabric softener into the dispenser. Softener is added automatically during the rinse portion of the cycle. Dilute liquid fabric softener by filling the dispenser with warm water until liquid reaches the underside of the rim. See max fill line arrows.



Style 2: Without liquid fabric softener dispenser (on some models)

- In the final rinse only, add fabric softener that has been diluted with ½ to 1 cup (125 to 250 mL) warm water.
5. Close the washer lid. Washer will not agitate or spin with the lid open.
6. Turn the LOAD SIZE or WATER LEVEL selector to the correct setting for your wash load and the type of fabric being washed.
- You may change the load size or water level selection after the washer has started filling by turning the selector to a different setting.
 - On models with a variable Load Size or Water Level control, you should turn the knob to RESET, then to desired setting.

7. Select a Wash Temperature based on the type of fabric and soil being washed. Use the warmest wash water safe for the fabric. Follow garment label instructions.

The Automatic Temperature Control (ATC) (on some models) electronically senses and maintains a uniform water temperature by regulating incoming hot and cold water.

- Even in Cool wash, some warm water is let into the washer to maintain a minimum temperature of approximately 70°F (21°C).

Temperature Guide

Wash Temp	Suggested Fabrics
Hot	Whites and pastels Durable garments Heavy soils
Warm	Bright colors Moderate to light soils
Cool	Colors that bleed or fade Light soils
Cold	Dark colors that bleed or fade Light soils

NOTE: In wash water temperatures colder than 60°F (15.6°C), detergents do not dissolve well. Soils can be difficult to remove. Some fabrics can retain wear wrinkles and have increased pilling (the formation of small lint-like balls on the surface of garments).

8. You can customize your wash by adding rinse Options to your cycle selections. This knob has settings for:
- Extra Rinse - Selecting this option provides a second rinse. An Extra Rinse can be added to any wash cycle.
 - Cycle Signal - A tone will sound at the end of the cycle. The sound level cannot be adjusted.
 - Extra Rinse & Cycle Signal - This option combines both a Extra Rinse and a Cycle Signal at the end of the wash cycle.
9. The Sensi-Care™ System (on some models) is an integrated set of controls which work together to provide optimal wash temperatures, agitation times, and agitation/spin speeds based on the Fabric Select setting. The controls provide higher wash temperatures for more aggressive, heavy-duty cycles and slightly lower temperatures on cycles for delicate and hand wash items, to provide better fabric care. The timer knob allows you to decrease agitation time for light soils and increase agitation time for heavy soils.

10. Push in the Timer knob and turn it clockwise to the wash cycle you want. Reduce the wash time when using a small water level setting. Pull out the Timer knob to start the washer.



To stop or restart your washer:

- To stop the washer at any time, push in the Timer knob.
- To restart the washer, close the lid (if open) and pull out the Timer knob.

WASHER CARE

Cleaning Your Washer

Use a soft, damp cloth or sponge to wipe up any spills such as detergent or bleach from the outside of your washer.

Clean your washer interior by mixing 1 cup (250 mL) of chlorine bleach and 2 cups (500 mL) of detergent. Pour this mixture into your washer and run it through a complete cycle using hot water. Repeat this process if necessary.

Remove any hard water deposits using only cleaners labeled as washer safe.

Cleaning the liquid fabric softener dispenser (on some models):

1. Remove dispenser by grasping top with both hands and squeezing, while pushing upward with thumbs.
2. Rinse dispenser under warm water, then replace it.

NOTE: Some models are equipped with a liquid fabric softener dispenser. To avoid damage to the washer or clothing, do not wash clothes with the liquid fabric softener dispenser removed or add detergent or bleach to this dispenser; it is for liquid fabric softener only.

Water Inlet Hoses

Replace inlet hoses after 5 years of use to reduce the risk of hose failure. Periodically inspect and replace inlet hoses if bulges, kinks, cuts, wear or leaks are found.

When replacing your inlet hoses, mark the date of replacement on the label with a permanent marker.

Moving and Storage

Because some water may stay in the hoses, freezing can damage your washer. If storing or moving your washer during freezing weather, winterize it.

Winterizing your washer

1. Shut off both water faucets. Disconnect and drain water inlet hoses. Pour 1 qt (1 L) of R.V.-type antifreeze into the basket.
2. Run washer on a drain and spin setting for about 30 seconds to mix the antifreeze and remaining water.
3. Unplug washer or disconnect power.

To use washer again

1. Flush water pipes and hoses. Reconnect water inlet hoses. Turn on both water faucets.

⚠ WARNING



Electrical Shock Hazard

Plug into a grounded 3 prong outlet.

Do not remove ground prong.

Do not use an adapter.

Do not use an extension cord.

Failure to follow these instructions can result in death, fire, or electrical shock.

2. Plug in washer or reconnect power.
3. Run the washer through a complete cycle with 1 cup (250 mL) of detergent to clean out antifreeze.

Storage, non-use or vacation care

Operate your washer only when you are at home. If you will be on vacation or not using your washer for an extended period of time, you should:

1. Unplug washer or disconnect power.
2. Turn off the water supply to the washer. This helps avoid flooding (due to a water pressure surge) while you are away.

TROUBLESHOOTING

First try the solutions suggested here and possibly avoid the cost of a service call...

Washer and Components

Noisy

- **Is the load balanced and the washer level?** The wash load should be balanced and not overloaded. The washer must be level. The front feet should be properly installed and the nuts tightened. Reset the rear leveling legs (if needed). See “Starting Your Washer.”
- **Did you completely remove the yellow shipping strap with cotter pins?** See “Remove Shipping Materials.”
- **Are the gears engaging after the drain and before spin, or is the upper part of agitator clicking during wash?** These are normal washer noises.

Leaking

- **Check the following:**
 - Are the fill hoses tight?
 - Are the fill hose washers properly seated?
- **Is the sink or drain clogged?** Sink and standpipe must be able to handle 17 gal. (64 L) of water per minute.
- **Is water deflecting off the tub ring or the load?** Center the tub before starting the washer. The wash load should be balanced and not overloaded. The fill or spray rinses can deflect off the load. The washer must be level. The front feet should be properly installed and the nuts tightened. Reset the rear leveling legs (if needed). See “Level the Washer.”
- **Check household plumbing for leaks.**

Basket crooked

- **Was the washer basket pulled forward during loading?** Push the basket to the center before starting wash.
- **Is the load balanced and the washer level?** The wash load should be balanced and not overloaded. The washer must be level. The front feet should be properly installed and the nuts tightened. Reset the rear leveling legs (if needed). See “Level the Washer.”
- **The washer basket moves while washing.** This is normal.

Agitator operation

- **The top of the agitator is loose, or moves in only one direction.** This is normal.

Dispensers clogged or bleach leaking

- **Did you follow the manufacturer’s directions when adding detergent and fabric softener to the dispensers (on some models)?** Measure detergent and fabric softener. Slowly pour into the dispensers. Wipe up all spills. Dilute fabric softener in the fabric softener dispenser.
- **Did you put powdered or color-safe bleach into the liquid chlorine bleach dispenser (on some models)?** Add powdered or liquid color-safe bleach directly to the basket. Do not use the chlorine bleach dispenser for color-safe bleach.

Washer Operation

Washer won’t run, fill, rinse or agitate; washer stops

⚠ WARNING



Electrical Shock Hazard

Plug into a grounded 3 prong outlet.

Do not remove ground prong.

Do not use an adapter.

Do not use an extension cord.

Failure to follow these instructions can result in death, fire, or electrical shock.

- **Is the power cord plugged into a grounded 3 prong outlet?** Plug power cord into a grounded 3 prong outlet.
- **Are you using an extension cord?** Do not use an extension cord.
- **Is the indicator on the Timer knob properly lined up with a cycle?** Turn the Timer knob to the right slightly and pull to start.
- **Are the water inlet valve screens clogged?** Turn off the water and remove inlet hoses from the washer. Remove any accumulated film or particles. Reinstall hoses, turn on water and check for leaks.

- **Are both the hot and cold water faucets turned on?** Turn on the water.
- **Is the water inlet hose kinked?** Straighten the hoses.
- **Does the water level seem too low, or does the washer appear to not fill completely?** The top of the agitator is much higher than the highest water level. This is normal and necessary for clothes to move freely.
- **Has a household fuse blown, or has a circuit breaker tripped?** Replace the fuse or reset the circuit breaker. If the problem continues, call an electrician.
- **Is the washer in a normal pause in the cycle?** The washer pauses for about 2 minutes during certain cycles. Allow the cycle to continue. Some cycles feature periods of agitation and soak.
- **Is the washer overloaded?** Wash smaller loads.
- **Is the lid open?** The lid must be closed during operation. Washer will not agitate or spin with the lid open.

Washer won't drain or spin

- **Is the drain hose clogged, or the end of the drain hose more than 96" (244 cm) above the floor?** See "Connect Drain Hose" for proper installation of drain hose.
- **Is the lid open?** The lid must be closed during operation. Washer will not agitate or spin with the lid open.
- **Is there excessive sudsing?** Always measure detergent. Follow manufacturer's directions. If you have very soft water, you might need to use less detergent.

Washer continues to fill or drain; cycle seems stuck

- **Is the top of drain hose lower than the water level in washer?** The top of the hose must be higher than the water level in the washer for proper operation. See "Drain System."
- **Does the drain hose fit too tightly in the standpipe, or is it taped to the standpipe?** The drain hose should be loose yet fit securely. Do not seal the drain hose with tape. The hose needs an air gap. See "Secure the Drain Hose."

Wash/Rinse temperature not what I selected

- **Are the hot and cold water inlet hoses reversed?** See "Connect the Inlet Hoses" for more information. As your frequency of loads washed increases, the water temperature may decrease for hot and warm temperatures. This is normal.

Washer Results

Load too wet

- **Did you use the right cycle for the load being washed?** Select a cycle with a higher spin speed (if available).
- **Did you use a cold rinse?** Cold rinses leave loads wetter than warm rinses. This is normal.

Residue or lint on load

- **Did you sort properly?** Sort lint givers (towels, chenille) from lint takers (corduroy, synthetics). Also sort by color.
- **Did you overload the washer?** The wash load must be balanced and not overloaded. Clothes should move freely. Lint can be trapped in the load if overloaded. Wash smaller loads.
- **Did you select the correct water level?** The water level should be correct for the load size. Clothes should move freely in the water.
- **Did you use enough detergent?** Follow manufacturer's directions. Use enough detergent to hold the lint in the water.
- **Did you line dry your clothing?** If so, you can expect some lint on the clothing.
- **Check the following:**
 - Was paper or tissue left in the pockets?
 - Is your water colder than 60°F (15.6°C)? Wash water colder than 60°F (15.6°C) may not completely dissolve the detergent.
 - Did you use the proper cycle time for the load? Reducing wash time (duration) is another way to reduce lint.

Stains on load

- **Did you follow the manufacturer's directions when adding detergent and fabric softener?** Measure detergent and fabric softener. Use enough detergent to remove soil and hold it in suspension. Dilute fabric softener and add to the rinse portion of a cycle only. Do not drip fabric softener on clothes.
- **Is there above average iron (rust) in water?** You may need to install an iron filter.
- **Did you properly sort the load?** Sort dark clothes from whites and lights.
- **Did you unload the washer promptly?** To avoid transfer of dye, unload the washer as soon as it stops.

Load is wrinkled

- **Did you unload the washer promptly?** Unload the washer as soon as it stops.
- **Did you use the right cycle for the load being washed?**
Use the cycle for Casual or Permanent Press clothes or another cycle with low spin speeds (if available) to reduce wrinkling.
- **Did you overload the washer?** The wash load must be balanced and not overloaded. Loads should move freely during washing.

To reduce wrinkling of permanent press clothes and some synthetic knits, use a large load size to provide more space.
- **Are the hot and cold water hoses reversed?** Check that the hot and cold water hoses are connected to the right faucets. See “Connect the Inlet Hoses.”

Load is tangled or twisted

- **Did you overload the washer?** The wash load must be balanced and not overloaded. Loads should move freely during washing.
- **Did you wrap items around the agitator?** Drop items loosely into the washer. Do not wrap items around the agitator.

Gray whites, dingy colors

- **Did you properly sort the load?** Transfer of dye can occur when mixing whites and colors in a load. Sort dark clothes from whites and lights.
- **Was the wash temperature too low?** Use hot or warm washes if safe for the load. Make sure your hot water system is adequate to provide a hot water wash.
- **Did you use enough detergent, or do you have hard water?** Use more detergent for washing heavy soils in cold or hard water.
- **Are the hot and cold water hoses reversed?** Check that the hot and cold water hoses are connected to the right faucets. See “Connect the Inlet Hoses.”

Garments damaged

- **Check the following:**

Were sharp items removed from pockets before washing? Empty pockets, zip zippers, snap or hook fasteners before washing.

Were strings and sashes tied to avoid tangling?

Were items damaged before washing? Mend rips and broken threads in seams before washing.
- **Did you overload the washer?** The wash load must be balanced and not overloaded. Loads should move freely during washing.
- **Did you add chlorine bleach properly?** Do not pour chlorine bleach directly onto load. Wipe up bleach spills. Undiluted bleach will damage fabrics. Do not place load items on top of the bleach dispenser when loading and unloading the washer (on some models).
- **Did you follow the manufacturer’s care label instructions?**

ASSISTANCE OR SERVICE

If you need assistance or service, please check “Troubleshooting.” If you still need help, follow the instructions below.

If you need replacement parts

If you need to order replacement parts, we recommend that you only use factory specified parts. These parts will fit right and work right because they are made with the same precision used to build every new MAYTAG® appliance. To locate factory specified parts in your area, call the dealer from whom you purchased the washer or a Maytag designated service company.

NOTE: If the power supply cord of this washer is damaged, it must be replaced by a special cord available from the dealer from whom you purchased the washer or a Maytag designated service company.

For warranty information

Contact the dealer from whom you purchased your washer.

NOTES

